

Qty. Description

1 SOLOLIFT2 C-3



Note! Product picture may differ from actual product

Product No.: [97775317](#)

Sololift2 C-3 is a small, compact automatic lifting station suitable for pumping of greywater (w/o faeces) off places in private dwellings where wastewater cannot be led directly to the sewer by means of a natural downward slope.

Sololift2 C-3 is typically used for:

- cabinet showers, washbasins, bath tubs, washing machines (max. 90°C) and dishwashers in basements below sewer level or in connection with the renovation or modernisation of existing buildings, where the location may be remote from the main soil pipe so that a natural slope cannot be established.

Sololift2 C-3 is suitable for installation under a washbasin or particularly for confined space conditions in prewall constructions and built-in cabinets. Extremely low switching levels for lowest construction heights, advantageously in case of connection of a shower receptor.

The compact lifting station is equipped with

- Cable with or without plug (see technical data)
- Horizontal or vertical fastening possibility of discharge hose connector with several adaptors for pipes with Ø22-40mm
- Integrated non return valve
- Dry and high performance motor unit incl. thermal protection, level switch and controller
- Flexible connectors for inlet (adjustable in height) of pipes Ø36 or 40
- Manual anti clogging function and separate drain connection for service
- Venting valve with overflow protection
- Uplift fixation clips

Design according to EN12050-2 and production inspection by external institute with unique features focused on quick installation, long lasting operation and easy clean service.

Note: The discharge adaptor can be mounted vertical or horizontal. Vertical installation increase the flow (s. databooklet and curves)

Liquid:

Liquid temperature range: 0 .. 75 °C

Selected liquid temperature: 20 °C

Density: 998.2 kg/m<sup>3</sup>

Technical:

Pump speed on which pump data are based: 2800 rpm

Rated flow: 1.7 l/s

Maximum flow: 3.4 l/s

Rated head: 5.95 m

Type of impeller: VORTEX

Max. Particle: 10 mm

Approvals: CE,SEPRO,CHROHS,MORO,AAA

Curve tolerance: ISO9906:2012 3B

Qty.	Description
1	<p>Materials:</p> <p>Pump housing: Composite</p> <p>Impeller: Polymer - PA</p> <p>Tank: PLASTIC PP</p> <p>Installation:</p> <p>Range of ambient temperature: 0 .. 40 °C</p> <p>Type of inlet connection: Smooth pipe</p> <p>Type of outlet connection: Smooth pipe</p> <p>Size of inlet connection: 32/36/40, 36/40/50</p> <p>Size of outlet connection: 22/25/28/32/36/40</p> <p>Pressure rating for connection: PN 1,5</p> <p>Number of leads: 3X0,75MM2</p> <p>Electrical data:</p> <p>Power input P1: 640 W</p> <p>Rated power - P2: 0.42 kW</p> <p>Mains frequency: 50 Hz</p> <p>Rated voltage: 1 x 220-240 V</p> <p>Rated current: 3.1 A</p> <p>Cos phi - power factor: 0.9</p> <p>Number of poles: 2</p> <p>Enclosure class (IEC 34-5): IP44</p> <p>Insulation class (IEC 85): F</p> <p>Power cable type: H05VV-F-3G</p> <p>Length of power cable: 1.2 m</p> <p>Power plug: SCHUKO</p> <p>Tank:</p> <p>Tank volume nominal: 6 l</p> <p>Others:</p> <p>Net weight: 7.75 kg</p> <p>Gross weight: 9.3 kg</p> <p>Shipping volume: 0.036 m<sup>3</sup></p> <p>Danish VVS No.: 614365632</p> <p>Swedish RSK No.: 5886547</p> <p>Finnish LVI No.: 4965315</p> <p>Norwegian NRF no.: 9045711</p> <p>Country of origin: RS</p> <p>Custom tariff no.: 84137021</p> <p>Environmental approvals: WEEE</p>

## 97775317 SOLOLIFT2 C-3 50 Hz

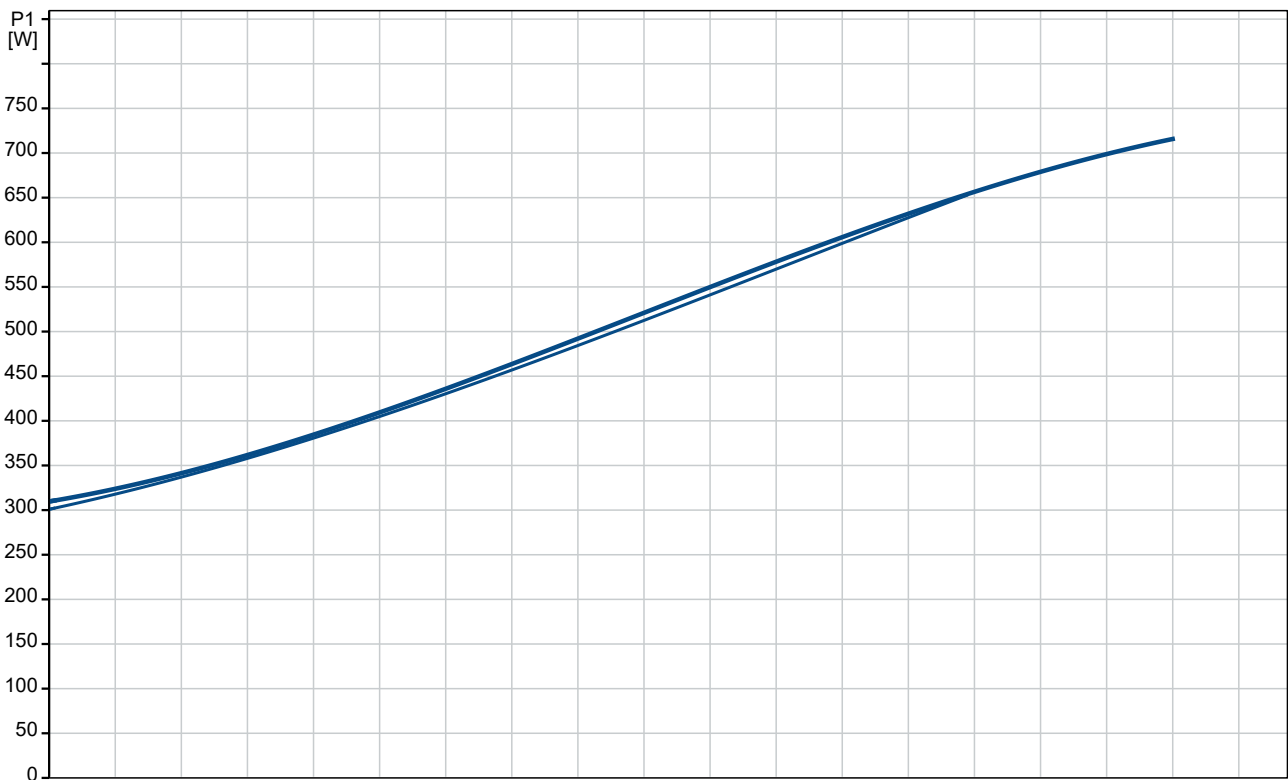
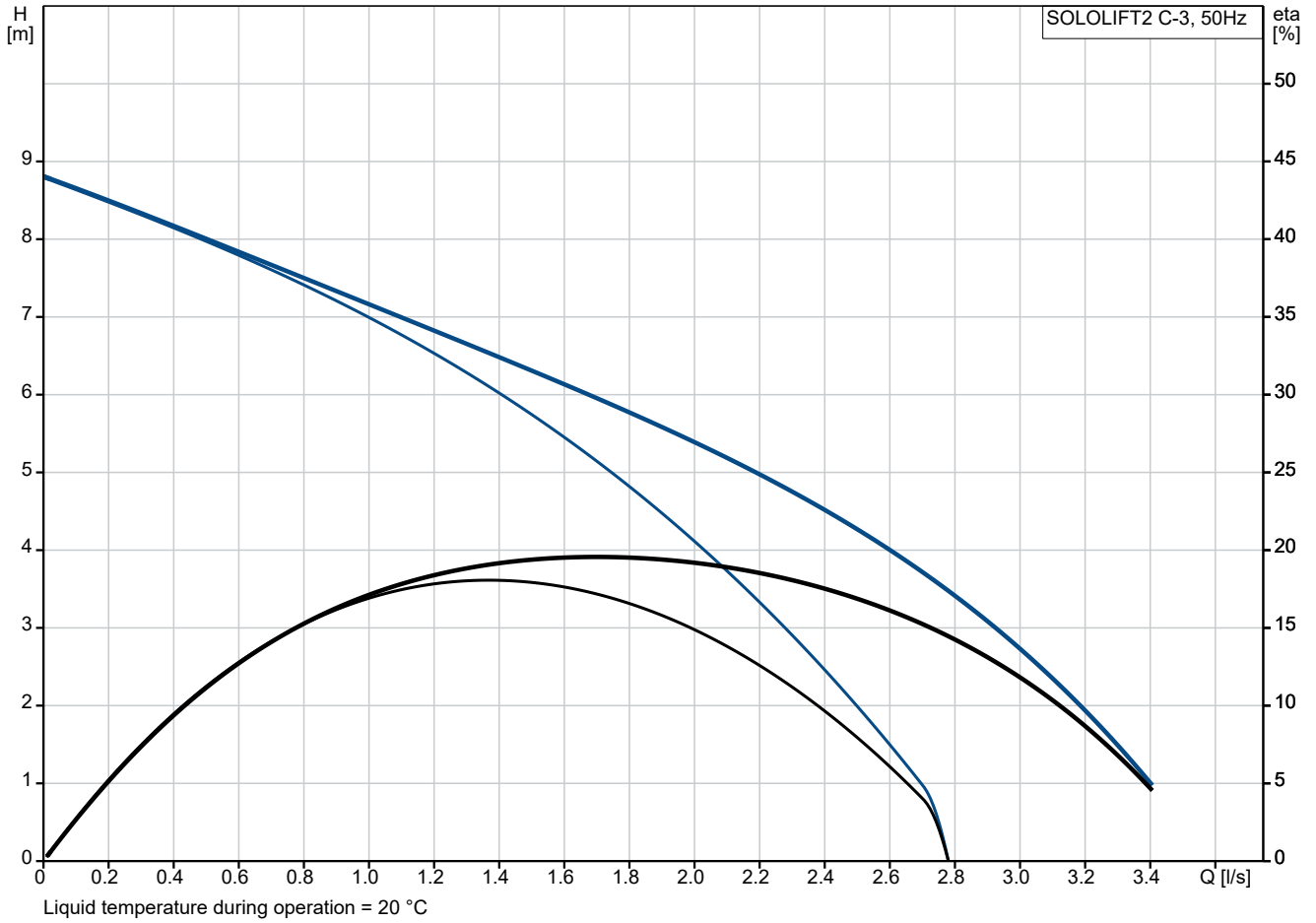

Description	Value
<b>General information:</b>	
Product name:	SOLOLIFT2 C-3
Product No:	97775317
EAN number:	5710624187265
Price:	EUR 761
<b>Technical:</b>	
Pump speed on which pump data are based:	2800 rpm
Rated flow:	1.7 l/s
Maximum flow:	3.4 l/s
Rated head:	5.95 m
Maximum head:	8.5 m
Type of impeller:	VORTEX
Max. Particle:	10 mm
Approvals:	CE,SEPRO,CHROHS,MOR O,AAA
Curve tolerance:	ISO9906:2012 3B
<b>Materials:</b>	
Pump housing:	Composite
Impeller:	Polymer - PA
Tank:	PLASTIC
Tank:	PP
<b>Installation:</b>	
Range of ambient temperature:	0 .. 40 °C
Type of inlet connection:	Smooth pipe
Type of outlet connection:	Smooth pipe
Size of inlet connection:	32/36/40, 36/40/50
Size of outlet connection:	22/25/28/32/36/40
Pressure rating for connection:	PN 1,5
Number of leads:	3X0,75MM2
<b>Liquid:</b>	
Liquid temperature range:	0 .. 75 °C
Selected liquid temperature:	20 °C
Density:	998.2 kg/m <sup>3</sup>
<b>Electrical data:</b>	
Power input P1:	640 W
Rated power - P2:	0.42 kW
Mains frequency:	50 Hz
Rated voltage:	1 x 220-240 V
Rated current:	3.1 A
Cos phi - power factor:	0.9
Number of poles:	2
Enclosure class (IEC 34-5):	IP44
Insulation class (IEC 85):	F
Thermal protec:	THERMIK S06-140-05
Power cable type:	H05VV-F-3G
Length of power cable:	1.2 m
Power plug:	SCHUKO
<b>Tank:</b>	
Tank volume nominal:	6 l
<b>Others:</b>	
Net weight:	7.75 kg
Gross weight:	9.3 kg
Shipping volume:	0.036 m <sup>3</sup>
Danish VVS No.:	614365632
Swedish RSK No.:	5886547
Finnish LVI No.:	4965315
Norwegian NRF no.:	9045711

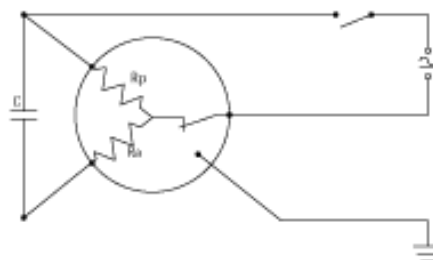
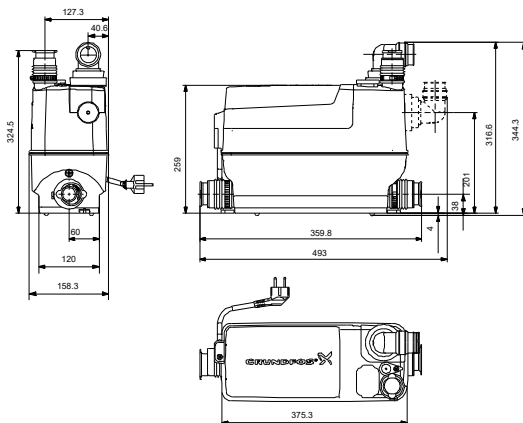
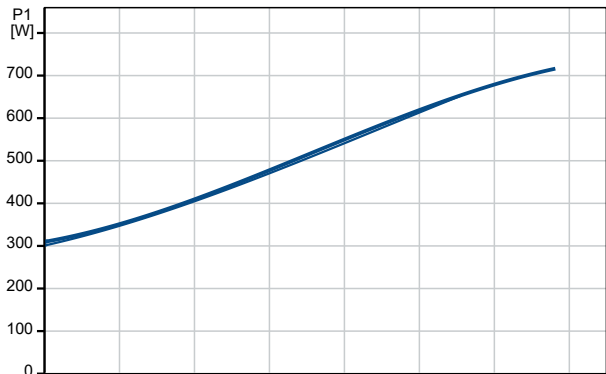
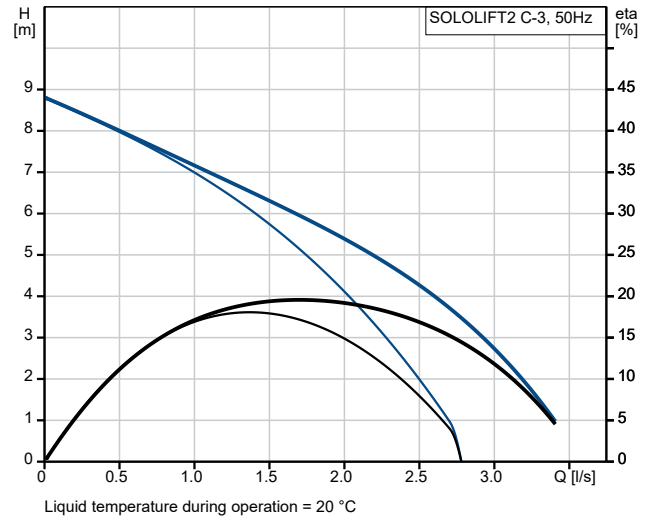



Company name:

Created by:

Phone:

Date:

13/06/2024

Description	Value
Country of origin:	RS
Custom tariff no.:	84137021
Environmental approvals:	WEEE

## 97775317 SOLOLIFT2 C-3 50 Hz

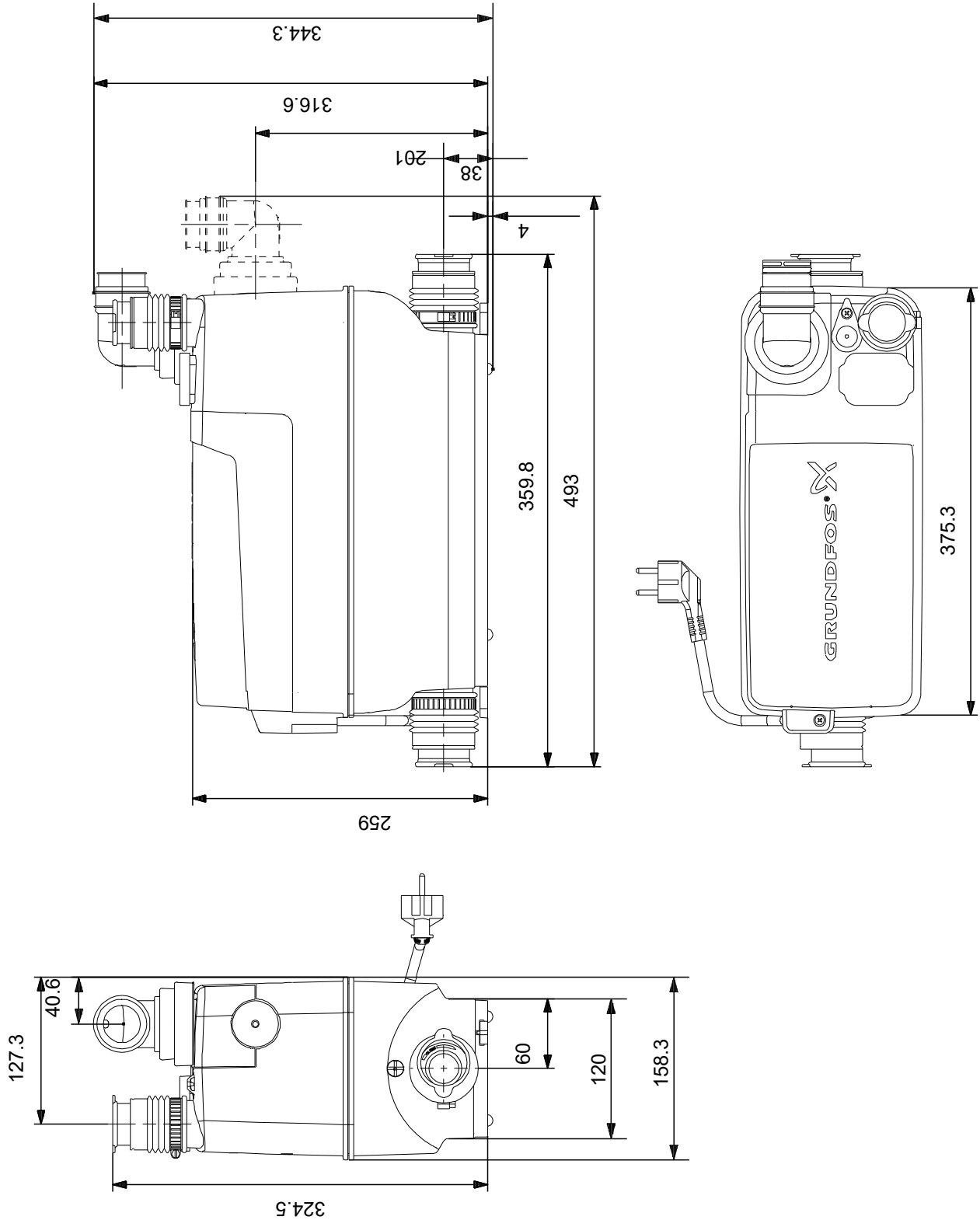

Note! All units are in [mm] unless others are stated.  
 Disclaimer: This simplified dimensional drawing does not show all details.

**97775317 SOLOLIFT2 C-3 50 Hz**

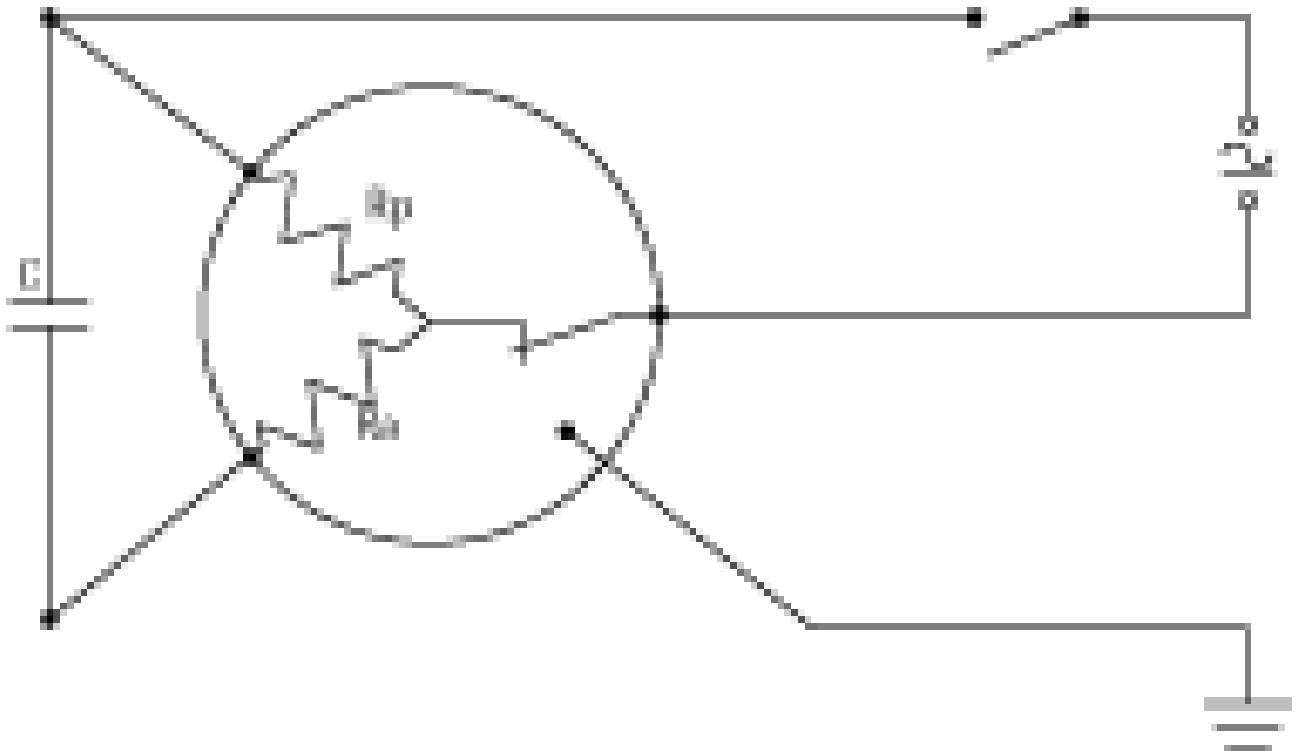

Note! All units are in [mm] unless others are stated.